

## Electronic filters design tutorial -2

In the first part of this tutorial we explored the bandpass filters designed with lumped elements, namely inductors and capacitors.

In this second part we will design filters with distributed components such as ceramic lines, stripline, resonators and cable filters.

During the exploration we will move from Spice simulator to electromagnetic simulator, to better understand the behaviour of distributed filters.

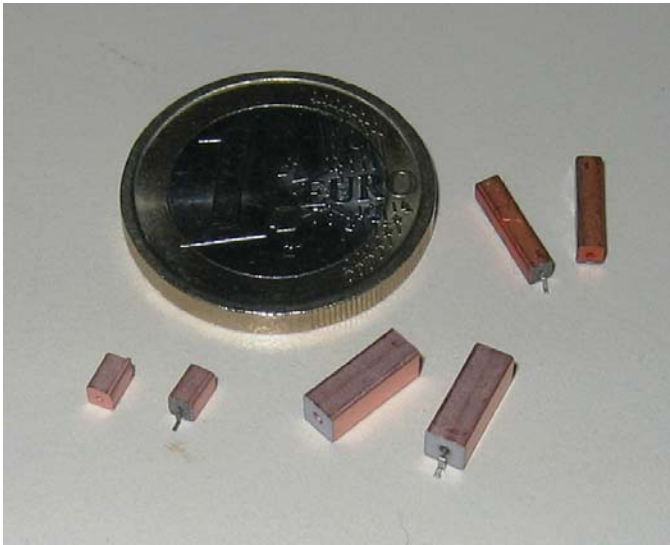

Fig1

In Fig1 we can see some ceramic resonators, from left to right: 2.45 GHz resonator at  $\lambda/4$  with shorted end, 3.85 GHz resonator at  $\lambda/2$  with open end, 900 MHz resonator at  $\lambda/4$  with shorted end.

As you can see these components are fairly small, and you can wonder if they are really distributed component, since the appearance is lumped. But the operating principle of  $\lambda/4$  or  $\lambda/2$  resonators is of course distributed. They are so small because the ceramic material with whom they are manufactured, has a high dielectric constant ( $\epsilon^r$ ) as high as 92; since the speed of electrons in a medium is equal to  $C/\sqrt{\epsilon^r}$ , the length of the resonator is reduced accordingly, in this case nearly 10 times.

The resonators are made in a coaxial fashion, and they appears as short sections of coax cable. The type operating in  $\lambda/4$  mode has one end shorted to ground (external electrode), this to use the property of a  $\lambda/4$  resonator that transform the short at one end (maximum current, minimum voltage) in an open circuit at the opposite end (minimum current, maximum voltage); this happens at the frequency of resonance only ( and unfortunately at all the odd

frequency multiples  $3/4\lambda$ ,  $5/4\lambda$ , etc.) at all the other frequencies it operates as a short circuit, making it a nearly perfect resonant circuit.

The "Q" is high (from 300 to 1000), the impedance of the line is low (from 4 to 16  $\Omega$ ), the tolerance in resonant frequency is less than 1%, practically a perfect element for constructing filters.

The  $\lambda/2$  type in the picture has no ground, you can consider it as a series connection of two  $\lambda/4$  resonators where the ground became virtual in the middle of the two.

What is the advantage of this type of connection? As you can see in the picture as frequency increase the resonator become shorter, the 2.45 GHz unit is a practical limit to manufacture. Making it shorter would impair precision, and metallization for grounding one end will add parasitic inductance in such a short line. Making  $\lambda/2$  resonator, the ground connection is avoided and the length is doubled, so you can increase the precision.

The 3.85 GHz resonator in the picture is also made of lower dielectric constant material ( $\epsilon^r=21.4$ ) making again the resonator longer. The "Q" of  $\lambda/2$  resonators is usually higher than  $\lambda/4$  types.

In fig.2 we can see a 1GHz filter manufactured with resonators compared to a lumped element filter with the same frequency of operation.

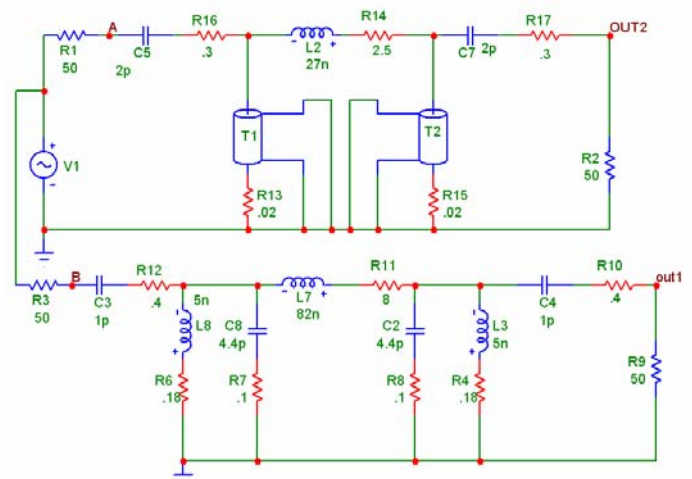

Fig.2

As usual all the parasitic loss of components are indicated in red.

On the top side of the diagram (OUT2) two monolithic resonators T1 and T2 are employed, with the following parameters: frequency at  $\lambda/4$  1.025 GHz, impedance  $Z_0 = 8\Omega$ , unloaded Q = 400.

## Electronic filters design tutorial -2

On the low side of the diagram (OUT1) the filter is constructed with two LC, composed of 5nH coils (mini-spring Coilcraft, Q of 180) and low loss ceramic capacitors with an unloaded Q of approximately 250.

In Fig.3 we can see the frequency response of the two filters. The loss is nearly half for the filter with monolithic resonator (red trace), and this is easily explained because the Q of the resonator itself is twice the Q of the LC circuit.

But what makes really the difference is that monolithic resonators have multiple resonating modes at  $\lambda/4$ , 3 times  $\lambda/4$ , 5 times  $\lambda/4$ , etc.

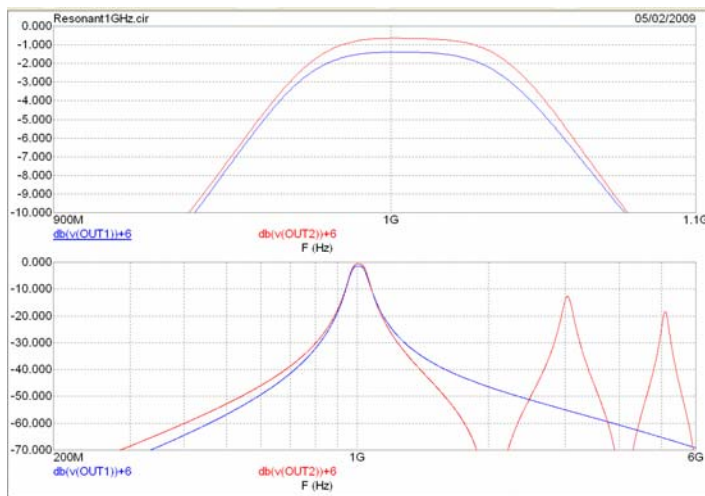

Fig.3

If the low loss is important, the monolithic resonator is the best solution, since models exist with a Q of 800 and the loss can be cut in half again to a mere 0.3 dB, the filter with LC resonator instead has already reached its limits with standard SMD components, and its loss of 1.4 dB can't be reduced significantly.

But using  $\lambda/4$  resonators you have to pay attention at spurious response: maybe they have no significance in your circuit, but probably, since spurious response are at the odd harmonics of the signal, maybe your design will need an additional low pass filter to cut the higher modes.

\* This is a very important fact, since all the filters made with  $\lambda/4$  or  $\lambda/2$  resonators exhibit the same behaviour!

A positive characteristic of monolithic resonators is their intrinsic precision in the resonant frequency. In fig.4 we can see a Monte-Carlo analysis of 200 run: the LC resonators (blue trace), even if the components has the narrowest tolerance available in standard components (2%) they exhibits a spread in characteristics at least

four times higher than monolithic resonators (red trace).

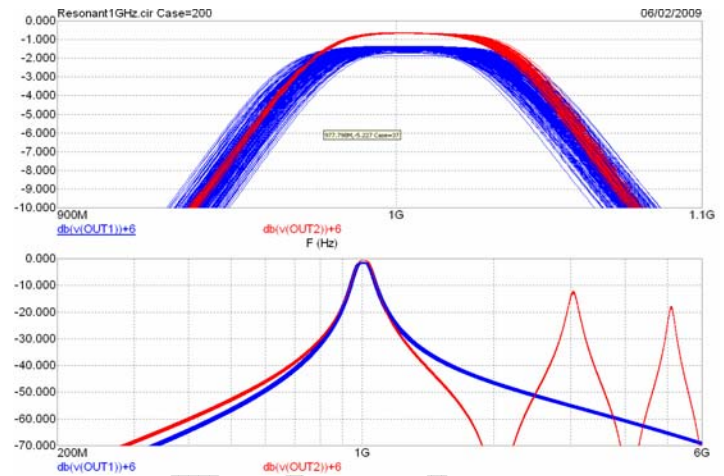

Fig.4

An important characteristic of monolithic resonators, is the possibility to move their resonant frequency via external components.

In fig.5 two capacitors are placed in parallel to the resonators T1 and T2 of fig.2, the value is stepped from 0 to 5 pF in 1pF step.

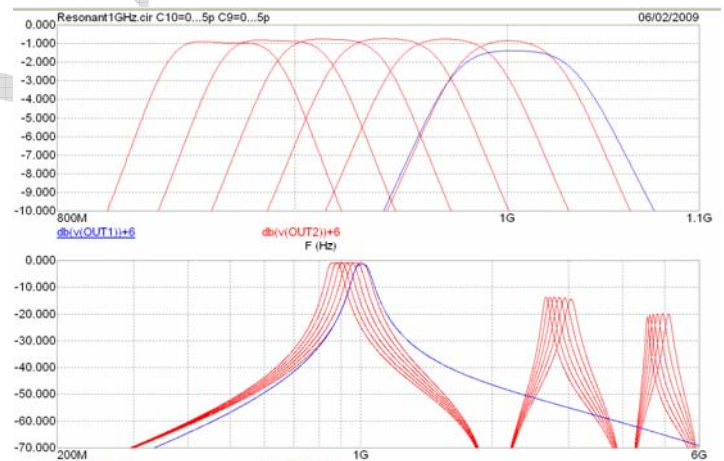

Fig.5

The frequency moves from 1 GHz without capacitor to 870 MHz with the 5 pF value. Of course the loss increase a bit, but the value is still acceptable (from 0.7 dB to 1 dB). Inserting an inductor in parallel to the resonator, the resonance will move higher than 1 GHz in the same fashion. A +/- 15% frequency shift can be obtained in this way.

\* This is an important approach, because current knowledge treats monolithic resonators as fixed frequency devices, instead a new degree of freedom is introduced, with the possibility of moving them in frequency.

## Electronic filters design tutorial -2

In fig.6 we can see the filter of fig.2 but with the resonators cut at  $\lambda/2$ , the losses are highlighted by the parallel resistors R13 and R15, since the bottom end of the resonators are left open in  $\lambda/2$  mode.

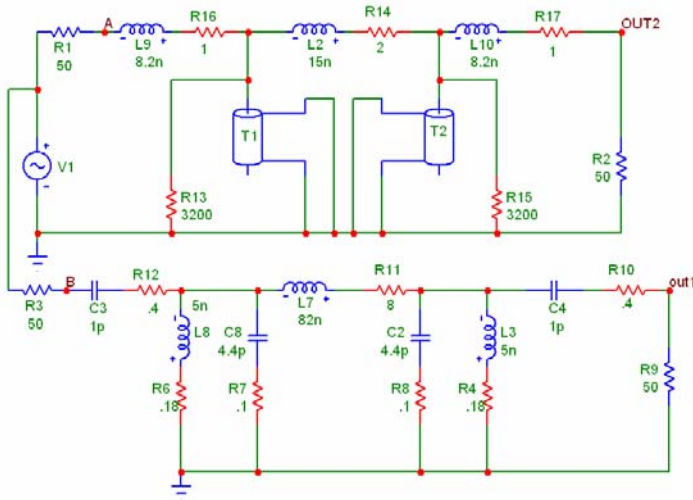

Fig.6

The coupling between the resonators is made with three inductors, instead of one inductor and two capacitors as in the previous case. In this way the filter is DC coupled and the response is in fig.7.

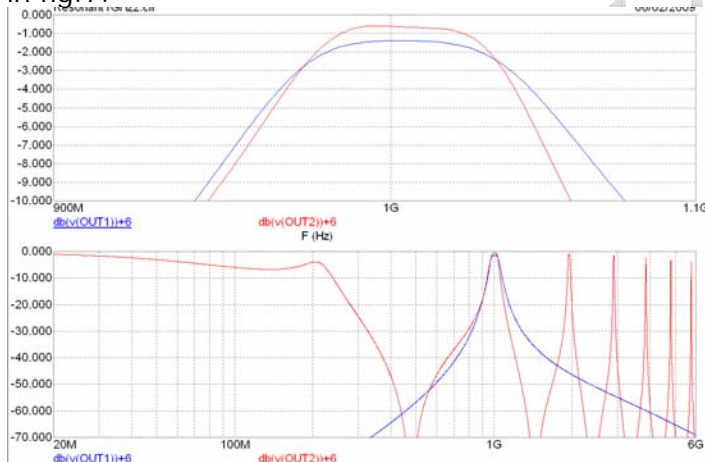

Fig.7

Two effects arise from the previous case, first the filter is no longer a "pure" bandpass filter since low frequencies pass from DC to approximately 220 MHz without attenuation, second the spurious response now is present at every harmonic of fundamental frequency, not only at odd ones.

The frequency response of the bandpass filter is no longer symmetrical, but it expresses a low pass function, cutting more the frequencies over the bandpass, see in fig 7 bottom, the shape of the response of the blue trace (LC filter) which is symmetrical and the response in red of the  $\lambda/2$  filter.

We can say that choosing  $\lambda/2$  resonator and inductor coupling isn't the best choice for a bandpass filter.

At least we can switch to the electromagnetic simulator program, to simulate the same filter of Fig.2 and see the results.

In fig.8 you can see the layout of the circuit, the two strip-lines has an impedance of 8Ω, exactly as the resonators T1 and T2 of fig.2.

The 8Ω impedance has been obtained keeping the line width of 6.5mm and a substrate thickness of 0.5mm. The dielectric constant  $\epsilon_r$  has been chosen to 9.8 (alumina) in order to keep the lines short. At 1GHz with  $\epsilon_r=9.8$  and dielectric loss tan. of 0.002, the length to  $\lambda/4$  is approximately 25mm.



Fig.8

The box used for the simulation is made of lossless metal, with dimensions of 40 x 30mm. The two resonators and the connecting traces are made of copper 35μm thick. The two ports [1] and [2] has 50 Ω impedance.

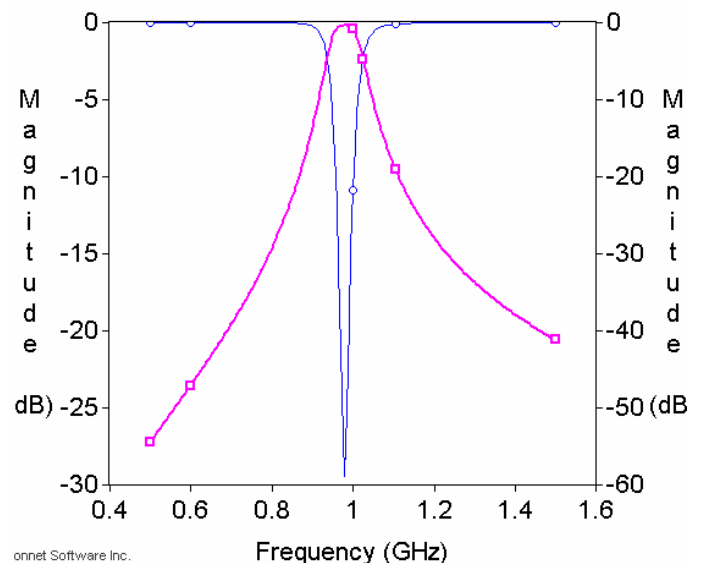
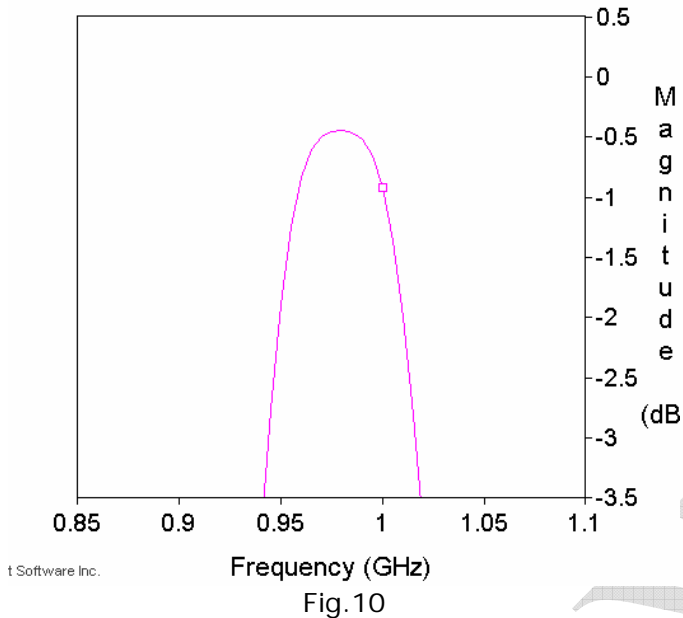

Fig.9

## Electronic filters design tutorial -2

The connection of the two resonators is made with the same components of fig.2, two 2pF capacitors and one 27 nH inductor. The two strip-lines are grounded at the edge of the box (perfect ground)

On fig.9 we can see the result of simulation, and in fig.10 the bandpass is enlarged to display the insertion loss.



The pink trace is the transmission response, and the blue one is the return loss. We can see that results are exactly the same as those of fig.3 (red trace), even the insertion loss is the same. Only a slight frequency shift occurs, the center frequency of fig. 10 is 975 MHz instead of 1 GHz. We remember that the two coaxial resonators of fig.2 has been corrected to 1.025 GHz in order to center the resonant frequency of the filter. Applying the same correction to fig.8 the result will be exactly the same.

\* It is impressive that using two completely different technology for simulation, one Spice and the other Electromagnetic, these bring to the same results! This means that both model are accurate, and this do not happen so frequently in everyday life. Maybe I win a coffee from some sceptical readers which do not believe in Simulator at all.

Going ahead in our simulation, we can try to abolish the lumped components present in the circuit and make the filter only with distributed ones.

In fig.11 the two coupling capacitors has been replaced by a tap connection to the resonators,

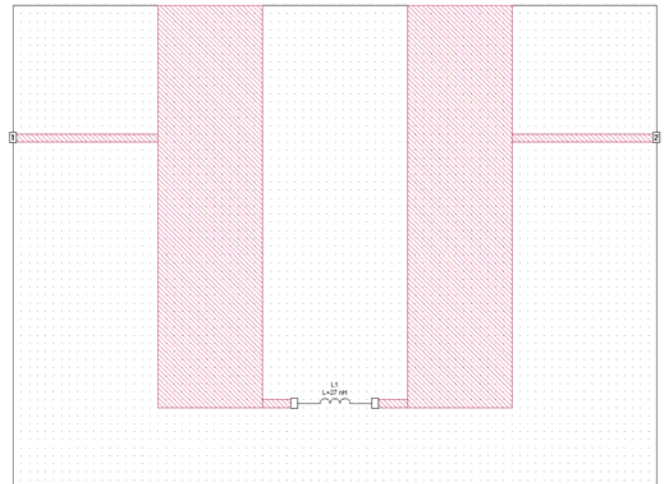

Running the simulation, it appears that the substitution is feasible and the results are comparable to that of the original circuit (fig.12), the pink trace displays the insertion loss and the blue trace shows the return loss.

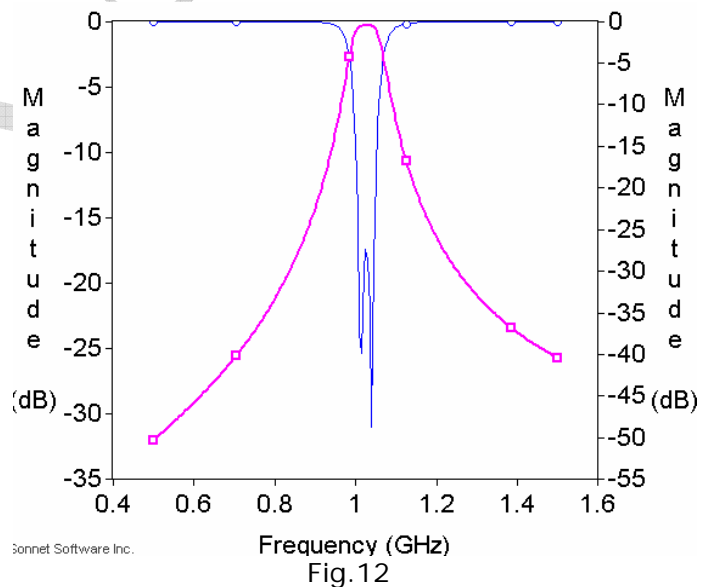

The principal difference respect to the previous circuit is that now the central frequency is slightly higher than 1 GHz, probably because the two coupling capacitors of 2 pF, now removed, were responsible for the frequency lowering.

Another step ahead is the removal of 27 nH inductor and use instead direct electromagnetic coupling of the two resonators.

Correct coupling is reached easy, simply moving the resonators in closed proximity, till the coupling is optimal.

## Electronic filters design tutorial -2

In Fig 13 appears the optimized circuit with a distance between resonators of 0.5 mm.

This is a very short distance, but remember that even the substrate thickness is thin (again 0.5mm)

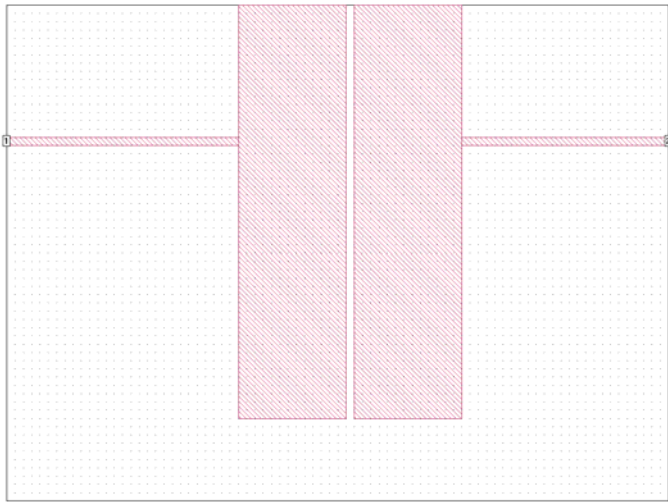

Fig.13

Now the filter is completely made of distributed element and the three discrete components has been removed. In Fig.14 you can see the frequency response (pink) and the return loss (blue)

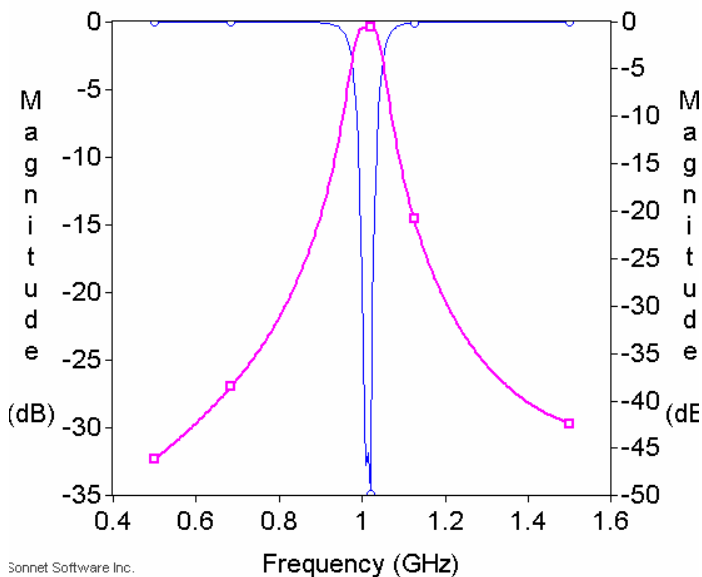

Fig.14

Till now we made frequency sweep around the passband, now it is time to make a broadband sweep, to check if stripline filter has the same ugly attitude to resonate at odd harmonics of the central frequency.

The response is even worse, since all the distributed component are broadband and there

are no inductances that compassionately cut higher frequencies. In fig.15 appears that the 3<sup>rd</sup> harmonic response has the same level as the 1GHz response, while the 5<sup>th</sup> harmonic has some loss and the response is broaden, since at 5GHz transversal modes start to occur in the resonators.

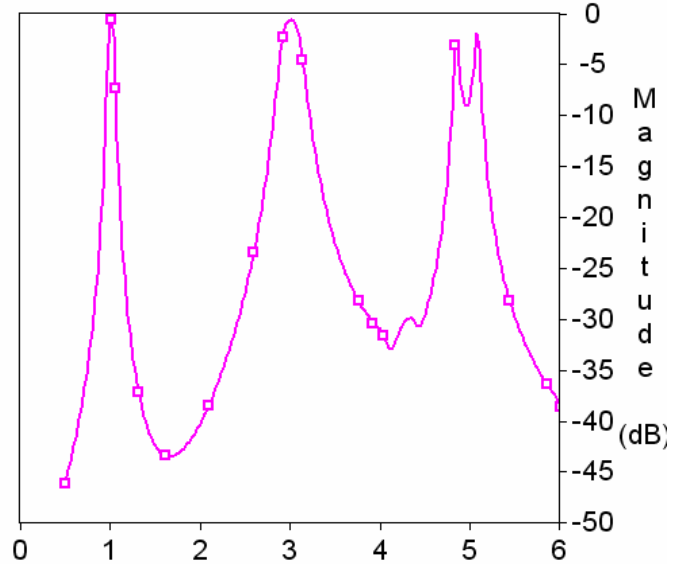

Fig.15

\* Introducing the folded resonators filters. Usually the substrates used to manufacture filters are made of Teflon or Epoxy, and the  $\epsilon_r$  is in the range of 2.2 to 4.5. This makes resonator longer, and if the circuit is operating at 1GHz or below dimensions are a concern. The best way to reduce dimensions is to fold resonators many times, to reduce dimensions. In fig.16 the two resonators are folded two times to reduce overall dimensions.

## Electronic filters design tutorial -2

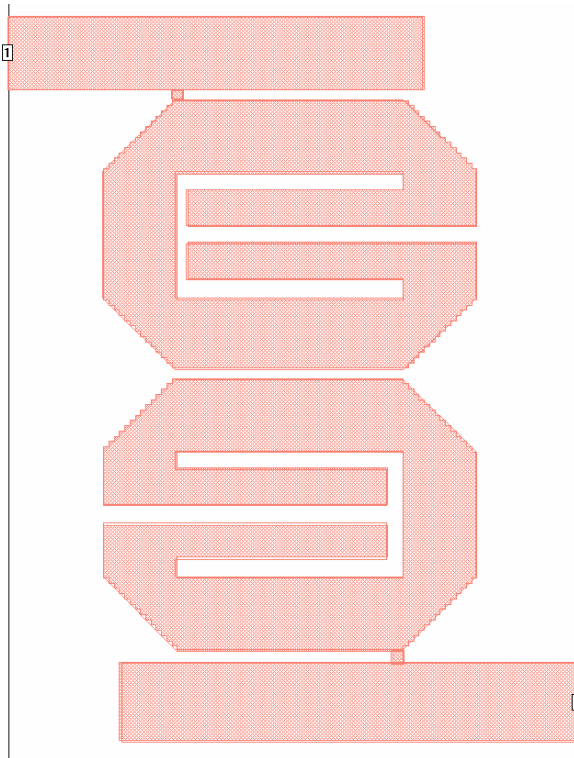

Fig.16

The dimensions of the circuit are 43 x 55mm, it is manufactured on epoxy substrate with  $\epsilon_r = 4.5$  and thickness of 2.4mm. Tangent loss is 0.01. The metal is copper with a thickness of 35 $\mu$ m. The box is made of lossless metal and the ports are at 50 $\Omega$ . In Fig.17 the response is displayed.

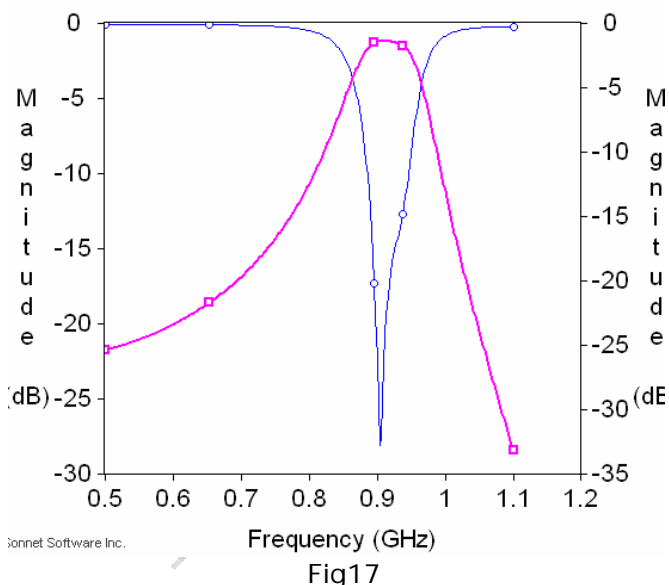

Fig17

The resonant frequency is approximately 900 MHz and the loss in the BW is approximately 1.5dB. Manufacturing a sample of the circuit we find correct the central frequency and the shape of the filter, but the loss was approximately 3.9dB

To understand where the losses are located, if in the dielectric or in the copper we made two other

simulation, one with the circuit made of lossless metal and the insertion loss decreased slightly at 1.2dB.

The second simulation with copper metal and lossless dielectric makes the difference, since loss goes to 0.3dB.

Clearly the abnormal loss in the physical prototype is located in the dielectric of epoxy-glass board.

A subsequent run was made setting the tangent loss to 0.03 and the in BW loss increased to 3.5dB.

A second prototype was built using a TMM4 Roger laminate for microwave, with a loss of only 0.002. The simulation gave a loss of 0.6dB and the physical prototype a loss of 1.1 dB..... a quite good agreement, considering that in the real world some parasitic radiation occurs.

\* Real world loss: consider that the loss of the physical prototype will be always higher than the simulation. You can correct the situation increasing the loss of dielectric and copper, but it is difficult to exactly manage it.

In the case of epoxy-glass board the divergence is sensational since epoxy is only characterized at 1MHz and at 1 GHz the loss increases 3 to 5 times.

\* Current distribution:

From electromagnetic simulation you can extract a lot of useful information, editing the loss parameters you can see where the main losses are located. Another very useful parameter is current distribution at different frequencies.

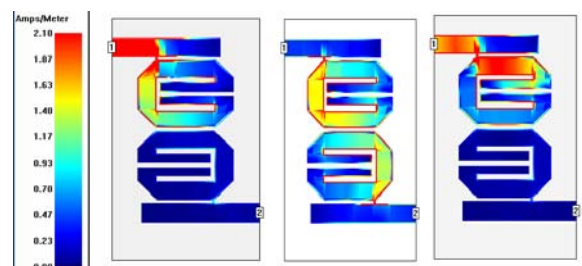

Fig.18

In Fig.18 the current is displayed at 682, 906 and 1100 MHz.

As you can see out of resonance the current does not cross to the second resonator to the output, while in resonance the two resonators are crossed by an equal current (minus the losses).

It is important to see that out of resonance the current in the first resonator is higher than the current in resonance. This is usually produced by stationary waves and must be accounted if the circuit is excited with high power.

## Electronic filters design tutorial -2

I hope all these tips about electromagnetic simulation has move your interest in this technology. A good book is listed in Reference (8).

Now we look at the various component that can be build directly into the PCB, in fig. 19 there are some examples of capacitors and inductors built from traces.

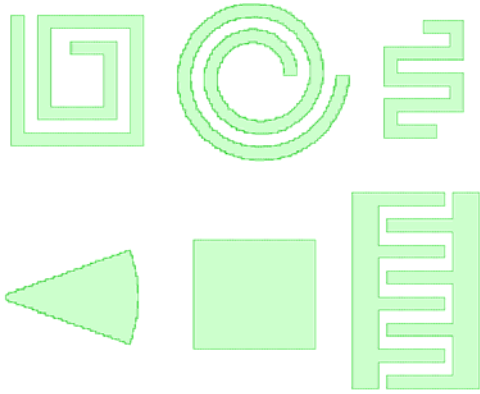

Fig.19

From right to left we can see three inductors: square, spiral and meander. On the bottom there are three capacitors: stub, rectangular and interleaved. Of the three inductor the most common is the square, because it requires less memory in the simulation then the spiral one. If the interior of the inductor isn't connected to ground it requires a jumper to connect it to the rest of the circuit. This can be done with the addition of a layer into the PCB or adding an SMD jumper (a zero  $\Omega$  resistor) on the contrary the meander inductor doesn't need an additional layer for the connection. The stub capacitor has broadband response and is useful for by-passing. The square capacitors has a more precise value of capacity, it can also be round, oval and rectangular. Both these capacitors are only usable with an armature to ground. The alternative is to use a multilayer PCB, choosing the height of the layers in a way to minimize the capacity versus ground, and improve the floating capacitance. The interleaved capacitor instead can be constructed without additional layers.

Obviously a lot of different structures exist, using multilayer construction, coupled lines and transformers. In this tutorial only the simplest structures, made on a single layer over ground are presented, since are more simple and intuitive to learn.

In the next example a monolithic filter will be designed, with all the elements integrated into

the PCB. In fig.20 we can see the electrical diagram.

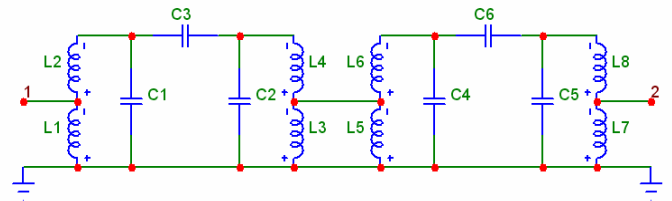

Fig.20

It is designed with tapped inductors coupling, because it is very easy with distributed components connecting to a tap for matching, as in fig. 10 where two capacitors were saved just with a connection in the right point of a strip-line. The circuit contain four resonators, in order to have a good rejection at out of band frequency, the passband is from 750 to 1000 MHz. The cutoff is enhanced at low frequencies, since the connection between resonators is capacitive and the response is of high-pass coupling type.

In fig.21 you can see the layout, it will be a good exercise to recognize the elements of the diagram in fig.20.

Dimensions of the filter are 54 x 8mm. The dielectric has a permeability of 4.5 and a loss of 0.02.

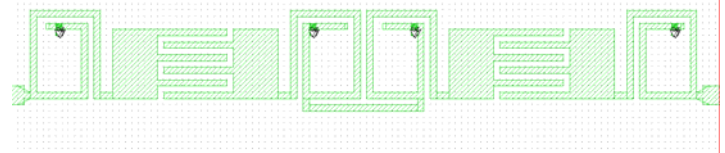
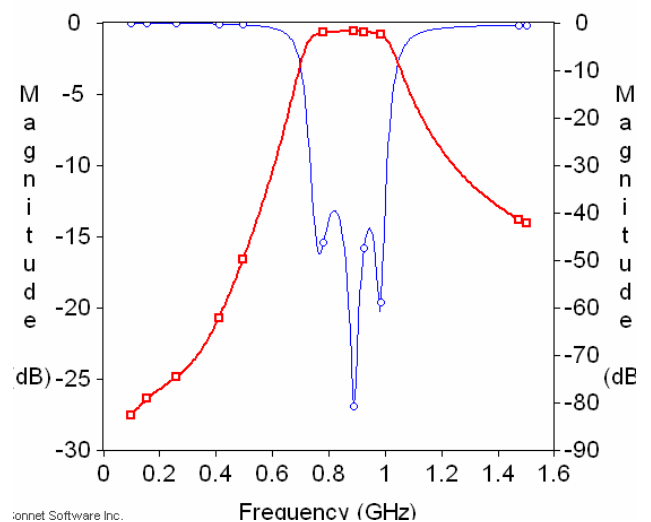

Fig.21

The response of the filter is in fig.22. The loss is 1.7 dB at the center of the band and drops to 3dB at the edges. The cutoff is over 60 dB at 400 MHz and 40 dB at 1.5 GHz.



# Electronic filters design tutorial -2

Fig.22

Running a wide band simulation, up to 8 GHz (fig.23) we can see that the response exhibits spurious peak at 4.5, 5.9 and 7.5 GHz.

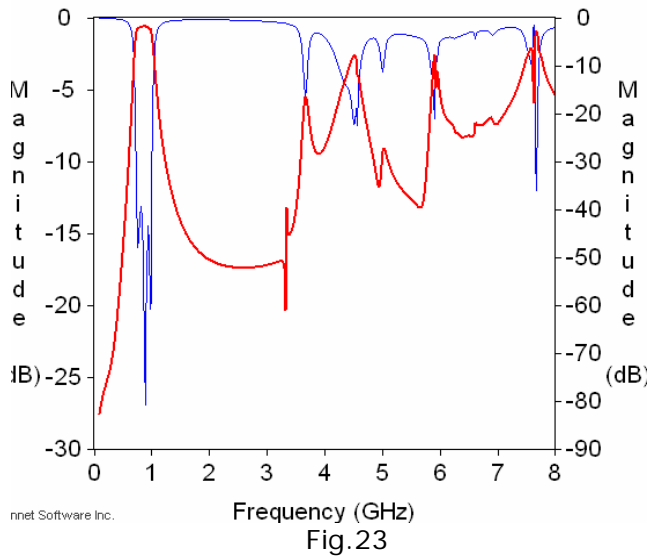

Fig.23

The spurious responses now are not related to multiples of the central frequency of the filter, but to the multiple resonances of the different lines, constituting the circuit.

Now we run simulation of a similar bandpass filter made of folded resonator, whose layout is in fig.24, dimensions are 55 x 52mm.

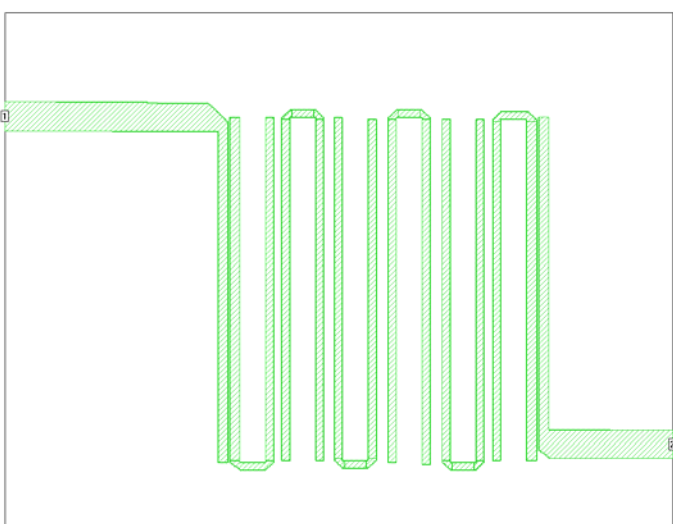

Fig24

The substrate has a thickness of 1.6mm, it is made of epoxy with  $\epsilon_r=4.5$  and loss of 0.02. Running the simulation (fig.25) we can see that the central frequency is 800 MHz and the BW is

approximately 100 MHz. The loss is very high, at 7.5 dB.

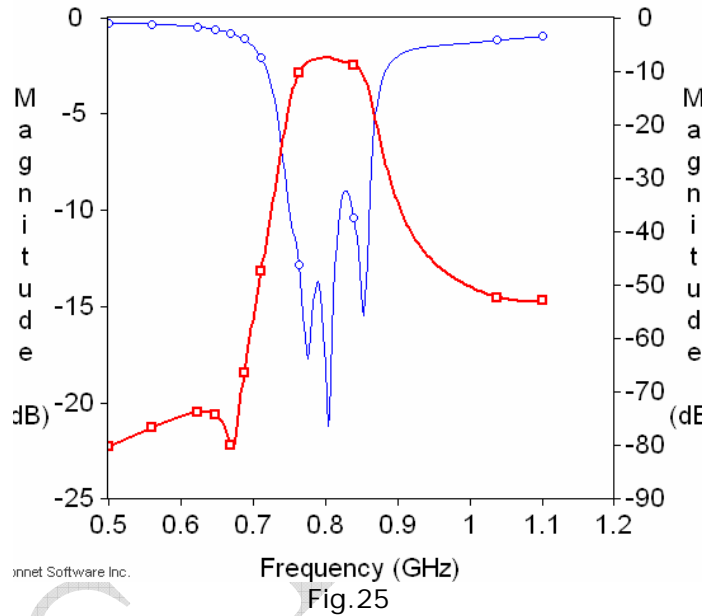

Fig.25

Running a second simulation, with a better substrate (Roger TMM4) with a loss of 0.002, ten times lower, we obtain a better loss in fig.26, from 2 to 3.1 dB in the BW.

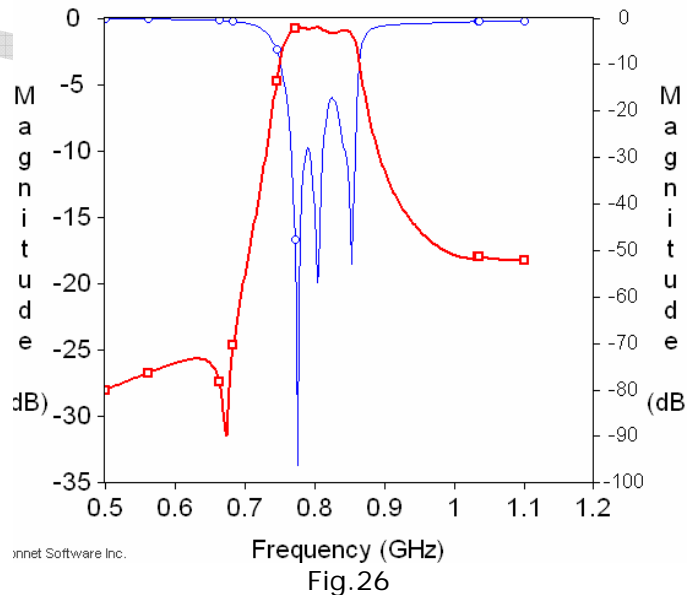

Fig.26

We can spend two words about the two different topology of the filter, even if they do not have exactly the same center frequency and BW. The folded resonator filter has an area six times wider and a loss 3 times higher, the response is a bit sharper because 6 resonators are used. However the technology of the filter with nearly lumped components is more compact and the loss is lower, permitting to manufacture it with a low cost material.



## Electronic filters design tutorial -2

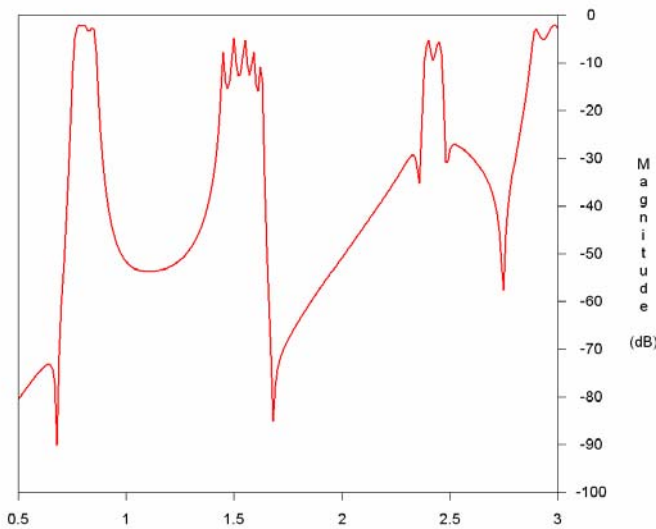

Fig.27

Moreover the filter with folded resonator exhibits spurious response at each harmonic, even or odd, of the central frequency (fig.27). On the contrary the other filter has spurious response less frequent and not related to the harmonics of the BW.

\* Conclusions: in this second part of this tutorial various typologies of distributed elements filters has been presented, the purpose was to help the reader in acquiring a physical understanding of electronic filters.

\* In the next section we will discuss about low-pass, high-pass and notch passive filters.

### Bibliography

- 1) MICROWAVE FILTERS, IMPEDANCE-MATCHING NETWORKS, AND COUPLING STRUCTURES  
G. Matthaei, L.Young, E.M.T. Jones  
1<sup>st</sup> edition 1964 ISBN:0-89006-0991.  
A Historical book, but still actual today
- 2) HANDBOOK OF FILTER SYNTHESIS  
Anatol I. Zverev ISBN:0-471-74942-7  
1<sup>st</sup> edition 1967  
A classical book on filter, full of tables for filter design
- 3) FILTERING IN THE TIME AND FREQUENCY DOMAIN  
A.I.Zverev, H.J. Blinchikoff  
1<sup>st</sup> edition 1976 ISBN: 1-884932-17-7  
Another classical book, perfectly useful today, you couldn't miss it in your library
- 4) INTRODUCTION TO THE THEORY AND DESIGN OF ACTIVE FILTERS

L.P.Huelsman, P.E.Allen ISBN:0-07-030854-3  
1<sup>st</sup> edition 1980

Another dated book, but still actual.

- 5) ELECTRONIC FILTER DESIGN HANDBOOK  
A.B.Williams, F.J.Taylor ISBN:0-07-070434-1  
1<sup>st</sup> edition 1981  
A practical book, containing a lot of tables.
- 6) CRYSTAL FILTERS R.G.Kinsman  
1<sup>st</sup> edition 1987 ISBN:0-471-88478-2  
A useful book for the engineers interested in crystal filters design.
- 7) COMPUTER-AIDED CIRCUIT ANALYSIS USING SPICE, W.Banzhaf ISBN:0-13-162579-9  
1<sup>st</sup> edition 1989  
A useful book about Spice simulation
- 8) MICROWAVE CIRCUIT MODELING USING ELECTROMAGNETIC FIELD SIMULATION  
D.G.Swanson, W.J.R.Hoefer  
1<sup>st</sup> edition 2003 ISBN: 1-58053-308-6  
A great book on electromagnetic simulation.
- 9) STRIPLINE CIRCUIT DESIGN Harlan Hove, Jr.  
1<sup>st</sup> edition 1974 ISBN:0-89006-020-7  
A good book on stripline circuits and components.

### Disclaimer

This document is provided for your personal use only and may not be retransmitted or redistributed without written permission from Redox srl. You may not distribute this document or part of it without prior written permission from Redox. You may not make copies for any commercial purpose. You do not obtain any ownership right, title, or other interest by downloading, copying, or otherwise using these materials. You assume the entire risk related to your use of this data. Redox srl is providing this data "as is," and Redox srl disclaims any and all warranties, whether express or implied, including (without limitation) any implied warranties of merchantability or fitness for a particular purpose. In no event will Redox srl be liable to you or to any third party for any direct, indirect, incidental, consequential, special or exemplary damages or lost profit resulting from any use or misuse of this data.